

LE4001

Assembly Instructions

Confirm all hardware is included before you begin assembly.

Supplied Parts:

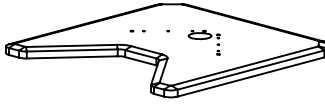

Bottom

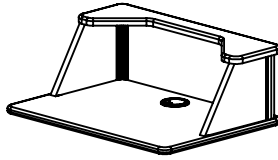

Top

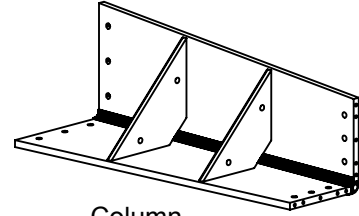

Column

Supplied Hardware:



Wood Dowel
(8)

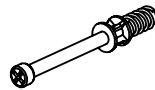

Metal Dowel
(12)



CAM connector
(12)

Tools required:

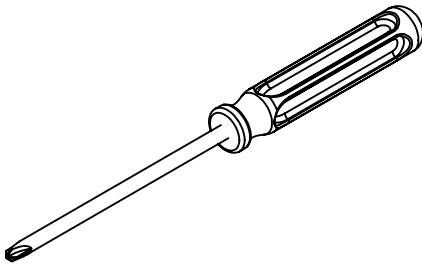

Pozidriv (SupaDriv) screwdriver

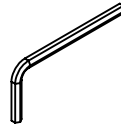

4mm (5/32") Hex Key

Step 1. Inserting Fasteners.

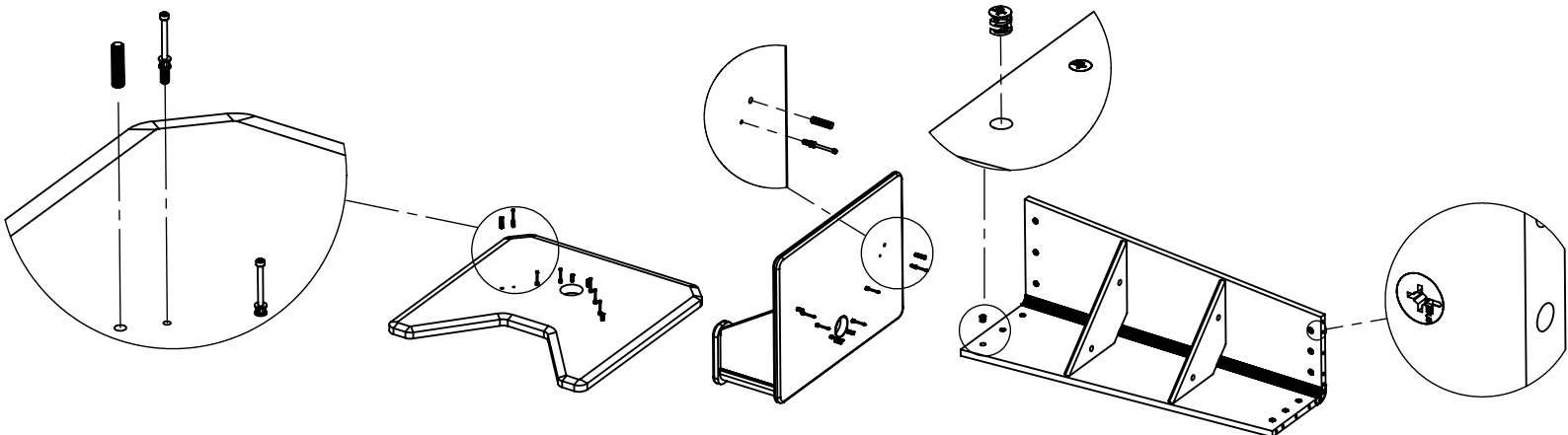

Step 2.

Attach Column to Bottom. Using Hex Key tighten CAM Connectors.

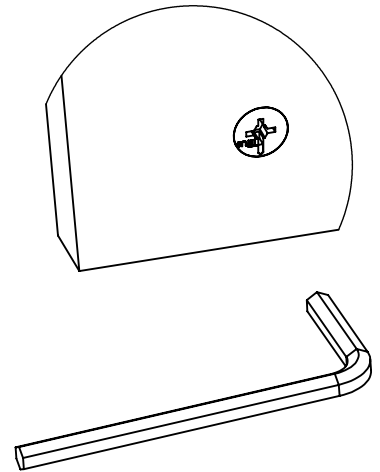
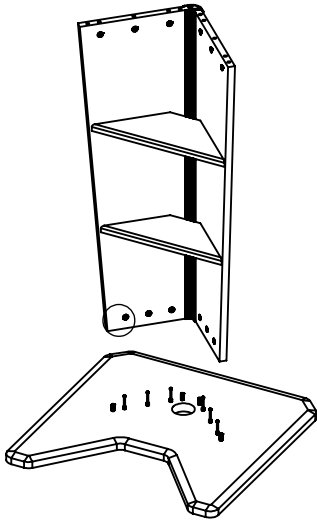

Step 3.

Attach Top to Column. Using Hex Key tighten CAM Connectors.

